



| | | |
|---------------------|-----------------------|----------|
| Installation Manual | | |
| Part No. | Description | |
| CDP Series | Pole Mounting Systems | |
| Revised By | Number | DATE |
| DONALD PIKE | F | 08/22/23 |

INSTALLATION AND OPERATING MANUAL FOR:

CDP SERIES

POLE MOUNTING SYSTEMS

| | |
|-----------------------------------|-------|
| ◆ POLE AND ARM FITTER | 1 |
| ◆ COMPOSITE CABLE HANDLING | 2 |
| ◆ CDP INSTALLATION INSTRUCTIONS | 3-4 |
| ◆ CABLE CLAMP INSTRUCTIONS | 5-6 |
| ◆ CDP INSTALLATION INSTRUCTIONS | 6-8 |
| ◆ ARM LEVELING INSTRUCTIONS | 9 |
| ◆ WIRE ROPE HANDLING INSTRUCTIONS | 10 |
| ◆ DRILL AND CLUTCH SPECIFICATIONS | 11-12 |
| ◆ PREVENTATIVE MAINTENANCE | 13 |
| ◆ OPERATING INSTRUCTIONS | 14-15 |

NOTE: - The installer must provide the 1.5" PVC conduit, PVC solvent cement and PVC fittings.
-The conduit must be attached to the conduit fitting provided by North Star Lighting.
-The raising and lowering cable must run inside the conduit.
-The conduit must terminate approximately 1 foot above the hand hole.

SAFETY WARNING

Please follow all state and local safety regulations while you are performing this work.
Reading and understanding this manual will significantly reduce the risk of injury.

Design **CDP6-16HDDN50-85SC**
**Arm and Disconnect Unit for Pole
Mounting Multi-Function Surveillance Cameras**

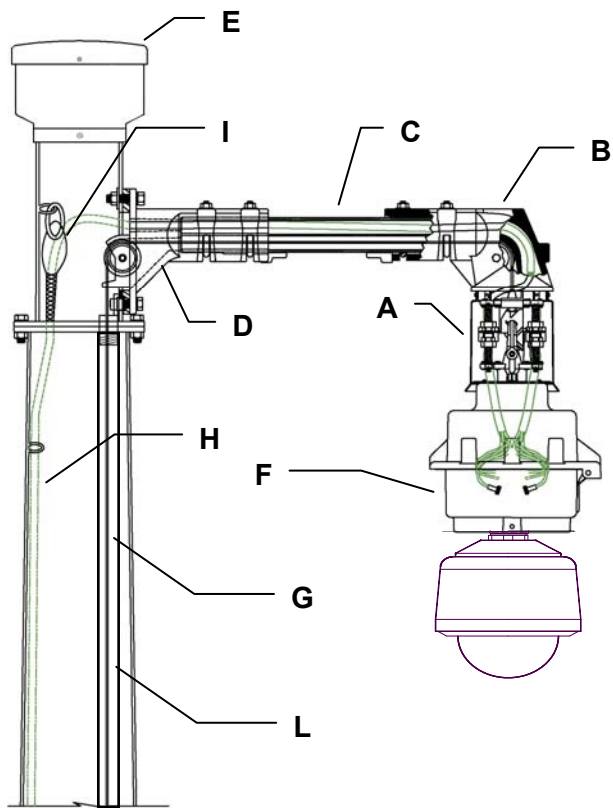

- A. ELECTRICAL AND SIGNAL DISCONNECT UNI WITH MULTI-CONTACT CONNECTOR.
- B. DISCONNECT UNIT FITTER WITH PULLEY AND U-BOLT MOUNTING FOR INTERLOCKING NON-ROTATING ARM.
- C. DIVIDED PIPE ARM: 2-3/8 IN. O.D. SEPARATES CONTROL CABLE AND ELECTRICAL AND SIGNAL WIRES. POSITION ALIGNED NON-ROTATING.
- D. POLE MOUNTED FITTER WITH PULLEY AND U-BOLT MOUNTING. FITTER MOUNTS DIRECTLY TO 6 INCH O.D. TENON AT TOP OF POLE.
- E. POLE TOP JUNCTION BOX WITH COVER SLIPS OVER 6" O.D. TENON.
- F. CAMERA CONNECTION BOX PROVIDED WITH STABILIZING WEIGHTS. EASY OPEN SWING DOWN DESIGN PERMITS QUICK ACCESS TO ELECTRICAL/SIGNAL WIRES FROM CAMERA ASSEMBLY.
- G. CONTROL CABLE CONSTRUCTED OF 5/32 INCH DIA. STAINLESS STEEL 7 X 19 CONSTRUCTION CABLE INSIDE 1 1/2" CONDUIT (CONDUIT BY OTHERS).
- H. ONE PIECE SIGNAL CORD WITH COAX AND POWER FROM DISCONNECT UNIT TO POLE BASE OR TO CABINET WITHOUT THE NEED OF EXTRA CONNECTORS.
- I. SIGNAL CABLE STRAIN RELIEF
- J. POLE (BY OTHERS).
- K. CABINET (BY OTHERS)
- L. CONDUIT FOR LOWERING CABLE (BY OTHERS)

TOTAL EPA (inc. arm assy. & camera): 2.50
TOTAL WEIGHT: 95 LBS.

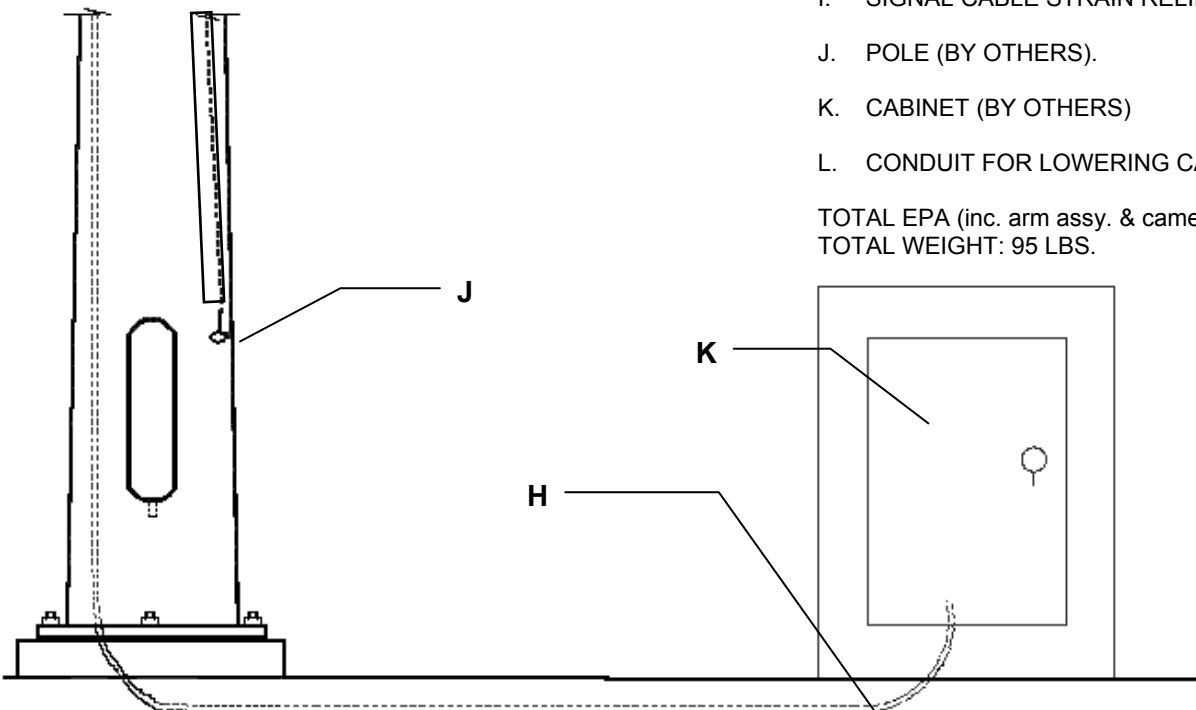

COMPOSITE CABLE HANDLING RIGHT and WRONG



The composite cable assembly consists of the coaxial cable, electrical power cables, twisted pair, and/or ethernet signal cable.

The composite cable is very delicate because of the signal carrying properties and should be handled with care.

There is a correct way to handle the composite cable assy and a wrong way.

DO NOT carry the CDP assembly by the cable. Pressure can be place on the cable, causing damage, possible breakage of wires. Also, the cable might pull off or partially off the crimped contact connector.

ALWAYS carry the CDP assembly as shown on the left. Take the pressure off the cable by putting the roll over the shoulder.

The CDP should be carried with both hands carrying the arm assembly as shown.

PREPARATION

1. Remove all items from cartons.
2. Make sure all component parts have been shipped. The CLS system consists of:
 - A. The arm/disconnect/cable assembly
 - B. Camera Junction Box
 - C. Pole Top Junction Box (if ordered)
 - D. Lowering tool assembly
 - E. Drill & Clutch (if ordered)
3. Have tools needed for installation.
4. Have 1 1/2" PVC and glue ready provided by Installer.



5. Pole must be positioned in a horizontal position, close to the installation location. It is preferred to have the top of the pole resting on a construction horse.
6. Concrete and Anchor bolts should have been poured.
7. Crane should be ready.

ASSEMBLY INSTRUCTIONS



1. First, glue the PVC tubes together and allow glue to dry.



2. Use a 'Rigid PVC Solvent Cement' to secure the PVC tubes together.
3. Install PVC into the pole from the top.
4. Trim off access PVC.



5. Remove PVC adaptor from 'Arm Assembly'.

CDP INSTALLATION INSTRUCTIONS

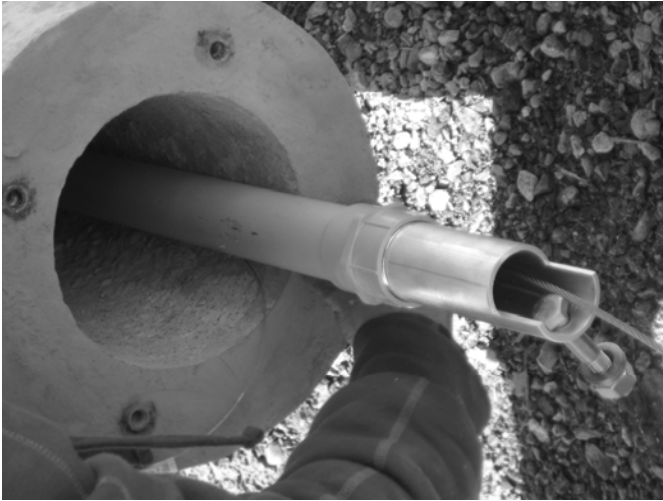

- 6. Connect conduit to conduit adaptor.
- 7. Unroll raising and lowering stainless steel cable like a garden hose. Careful not to kink the cable.



- 8. Using a 'fish tape', fish the cable thru the arm opening in the tenon, and into the conduit.
- 9. Attach the end of the cable with the connecting link, to the eye-bolt parking stand close to the handhole.
- 10. Unwind the composite (electrical/signal) cable like a garden hose.
- 11. With the help of the fish tape, feed the composite cable thru the arm opening in the tenon, and down the inside of the pole. Use eye-bolt guides to keep the cable close to the wall of the pole.

- 12. Bolt the arm to the tenon with the two 1/2" bolts provided.
- 13. Bolt the conduit adaptor to the lower 1/2" bolt.



- 14. Connect the strain relief to the eye-bolt in the tenon. Adjust the strain relief so as to allow slack in the electrical cable feeding into the arm.



- 15. Bolt tenon to top of pole. Make sure the arm is not underneath the handholes near the base of the pole.
- 16. With the raising and lowering cable attached to the eye-bolt near the base of the pole, loosen the cable clamp screws in the disconnect unit.
- 17. Pull the raising and lowering cable thru the clamp until there is only a small amount of slack (approx. 2-3").
- 18. Reassemble the cable onto the cable clamp and tighten the screws (see attached drawing)

CABLE CLAMP ASSEMBLY AND USE FOR SYSTEMS WITH LIFT CAPACITIES UP TO 400 POUNDS

WARNING: ● TO PREVENT SERIOUS PERSONAL INJURY, THE CABLE CLAMP MUST BE PROPERLY ASSEMBLED AND THE CABLE MUST BE PROPERLY ROUTED THROUGH THE CLAMP AS SPECIFIED WITHIN. NO ATTEMPT AT LIFTING ANY LOAD SHOULD BE MADE UNTIL ALL SPECIFICATION CONDITIONS ARE MET.

- DO NOT LIFT PEOPLE OR OPERATE ANY LOWERING SYSTEM OVER PEOPLE.
- USE ONLY 1/8 INCH OR 5/32 INCH DIAMETER 7x19 CONSTRUCTION CABLE WITH THIS CLAMP.
- THE ASSEMBLY WILL COME WITH CABLE LONGER THAN IS NEEDED.
- BEFORE THE FIXTURE IS ATTACHED, ATTACH THE QUICK LINK ON THE OTHER END OF THE CABLE TO THE EYEBOLT PARKING STAND NEAR THE HANDHOLE.
- THE CABLE SHOULD ONLY HAVE A SMALL AMOUNT OF SLACK (APPROX 4") WHEN THE DISCONNECT UNIT IS IN THE LOCKED (RAISED) POSITION.
- LOOSEN THE two No.10 SCREWS AND PULL THE CABLE THRU AS SHOWN BELOW.
- WHEN YOU HAVE 3" OF CABLE SLACK, TIGHTEN UP THE TWO No. 10 SCREWS.
- PUT ELECTRICAL TAPE AROUND THE CABLE AND CUT OFF ACCESS CABLE FROM THE END OF THE CABLE CLAMP. THE TAPE WILL KEEP CABLE FROM FRAYING.

FIXING CABLE IN CLAMP

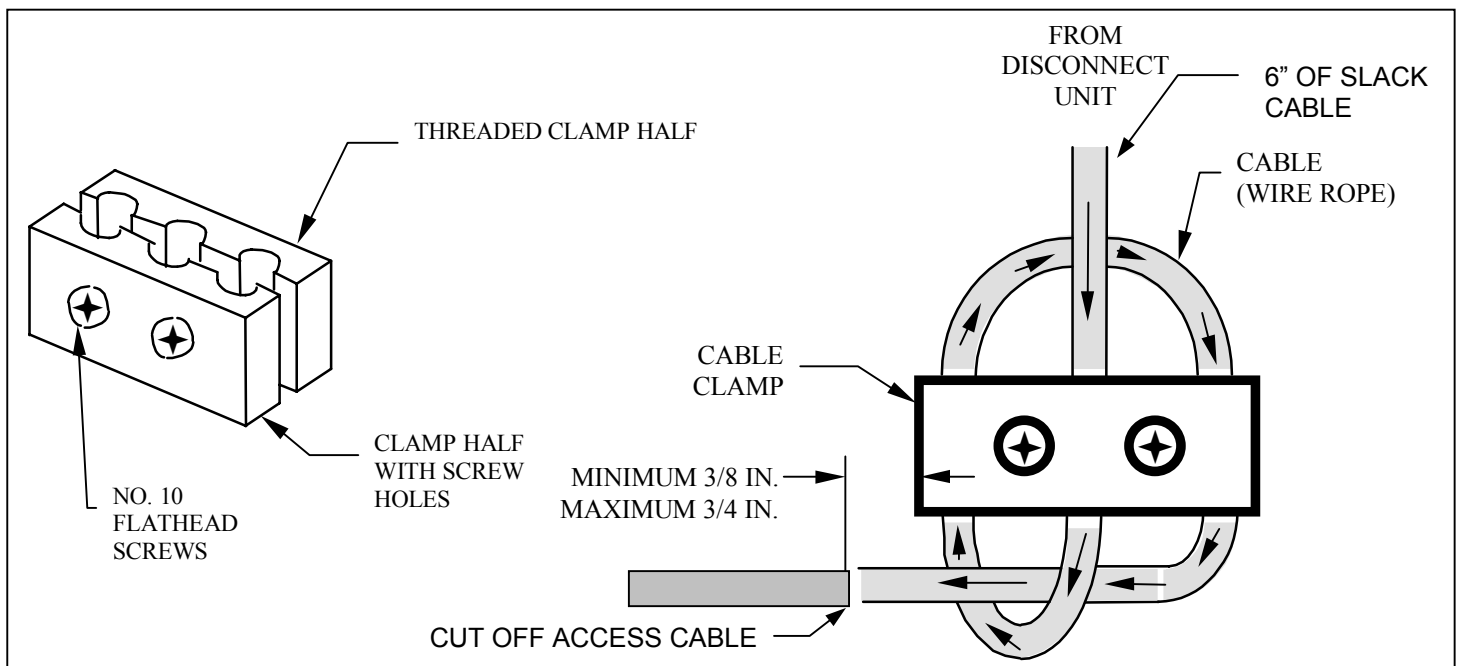

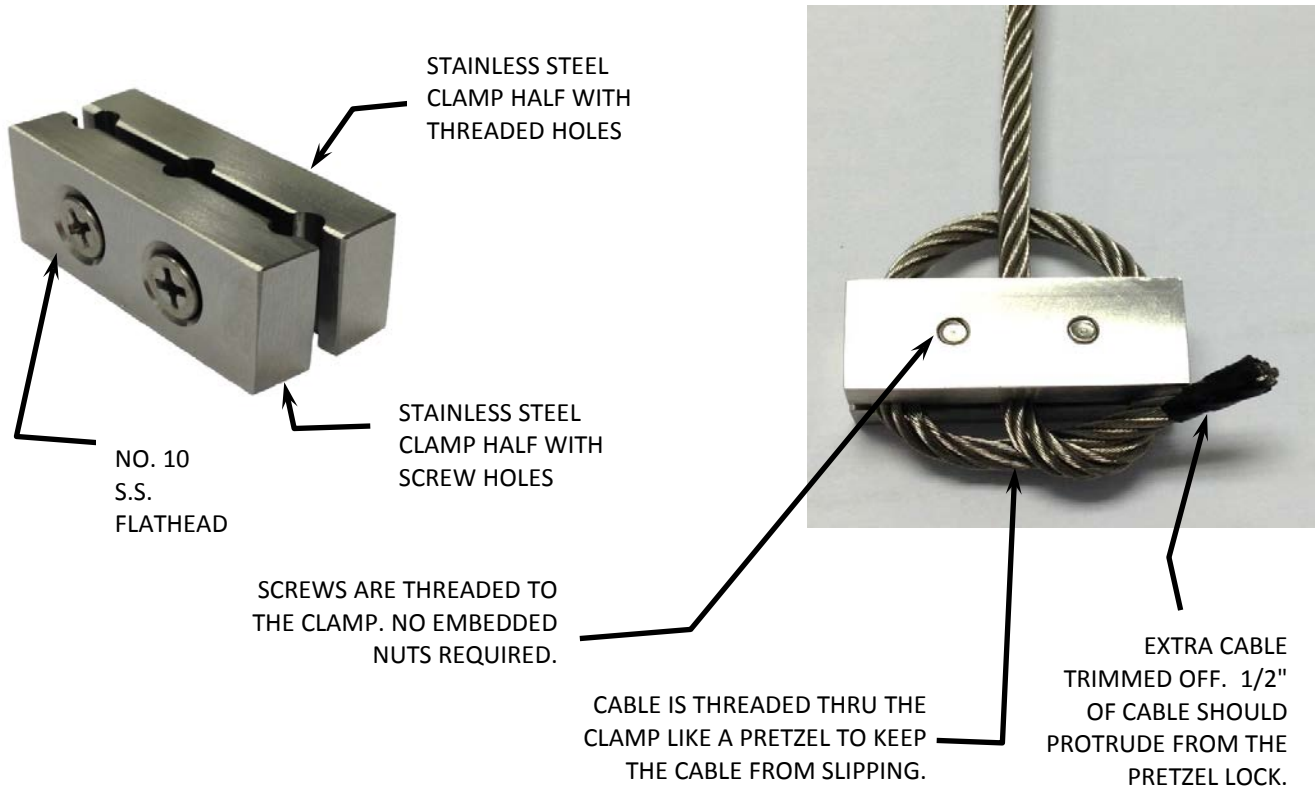

19. Cut the raising and lowering cable.
20. Reassemble the disconnect unit.
21. Put the disconnect unit in the locked position and tie a cord to the bolts on the bottom of the disconnect unit.
22. Mount the Pole Top Junction Box on top of the tenon.
23. Now the pole should be ready to be hoisted up.
24. After the pole is up and the anchor bolts are secured to the pole (or pole secured to ground in direct burial poles), bolt the lowering tool to the pole utilizing the 1/2" bolt.
25. Unwind several feet of cable from the lowering tool.
26. Connect the lowering tool cable to the camera lowering cable.
27. Unhook the cable from the pole eyebolt.
28. With the handle, manually lower the moveable portion of the disconnect unit by first cranking to remove the slack and raising the system an additional 3/4".
29. Reverse direction and lower the unit.
30. Gently pull on the cord attached to the moveable portion to unlock the unit, while lowering the unit.

ATTACHING THE CAMERA JUNCTION BOX

01. Lower the moveable portion of the disconnect unit down to working condition within 4ft from the ground.

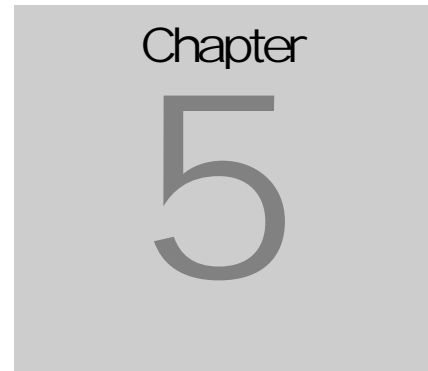
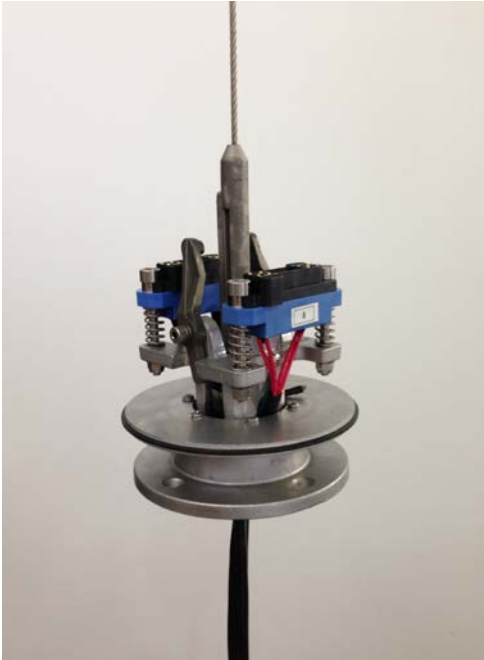

02. Unhinge the two clam shells of the Camera Junction box from each other.

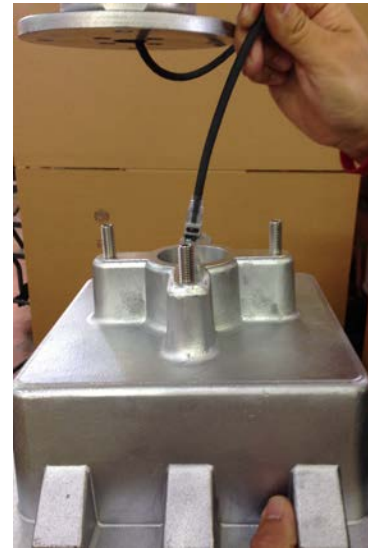
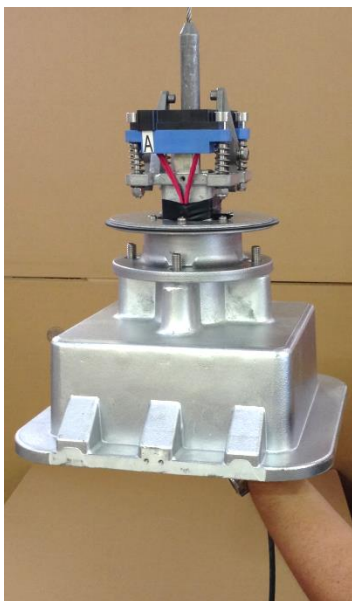

03. Put the communication cable from the lower half of the disconnect unit thru the opening of the upper half of the Camera Junction Box.

04. Align the four 3/8" threaded rods of the Camera Junction Box with the mounting flange of the lowered disconnect unit.

05. Attach washers and nuts provided, onto the threaded rod. After two nuts have been partially threaded onto the rods, it is not necessary to hold the upper half of the junction box.

06. Attach the rest of the hardware onto the rods and tighten.

07. Attach the bottom half of the junction box to the upper half with the 2 hinges.

08. Insert the communication wires into the box, and other hardware.

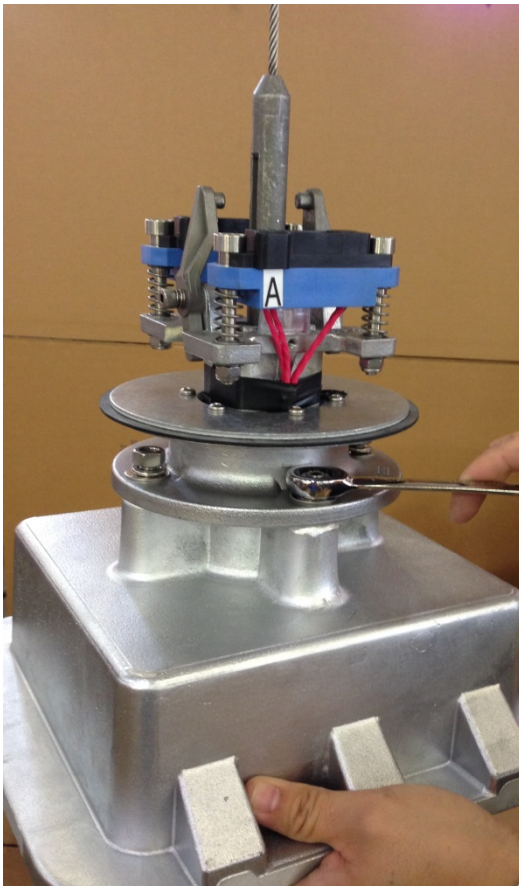
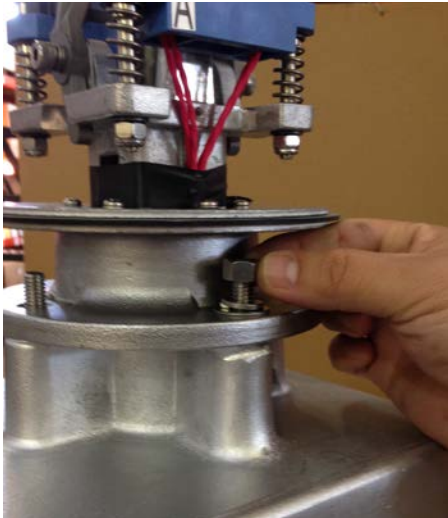

- 09. Close the box utilizing the stainless steel lock by turning the lock until it stops.
- 10. The box is now attached.
- 11. Check the center guide pin and make sure that it is well lubricated. It should come from the factory lubricated.

- 12. The Camera Junction Box has weights inside the box to allow the system to be lowered.
- 13. Raise the unit to the top. The drill can be used at this time. The drill should not be used during the operation of the last 1-2 feet. Manually raise the unit to the top.
- 14. Then reverse direction and lower the unit until there is slack in the cable.
- 15. Repeat the lowering and raising operations several times to make sure the system is operating properly.
- 16. If the camera is available, connect the camera to the junction box when lowered, and connect the signal/power cable.

MOUNTING THE CAMERA

- 17. When using a 1 1/2" threaded stem or the FLA-110 flange to mount the camera to the bottom of the Camera Junction Box, make sure to thread the male stem as far as possible.
- 18. Then USE **LOCTITE RED 271** on the 2 set screws provided, to tighten the stem to the CAMJB-10, to eliminate vibration that could loosen the stem or flange.

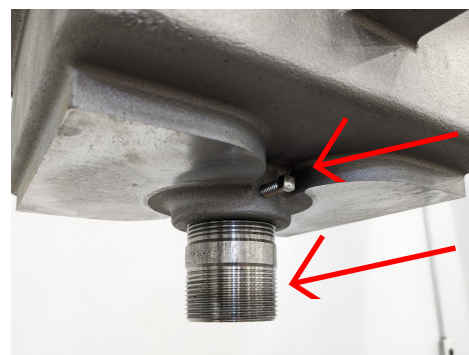

Set Screw

1 1/2" Threaded Pipe



LOCTITE Threadlocker RED 271

ADDITIONAL NOTES

Make sure that the pole and the arm assembly is level. The system will not work if the disconnect unit is not level.

Never operate the system over people. For safety precautions, people should stay clear of the assembly during the raising and lowering operation.

CLSCAMERA OWERING YSTEMS

LEVELING POINTS

PROVIDES ABILITY TO LEVEL DISCONNECT UNIT
FROM SIDE TO SIDE AND FRONT TO BACK ON
NON-PLUMB POLES

Leveling setscrew with locknut to
accommodate for front to back
adjustment of non-plumb pole.

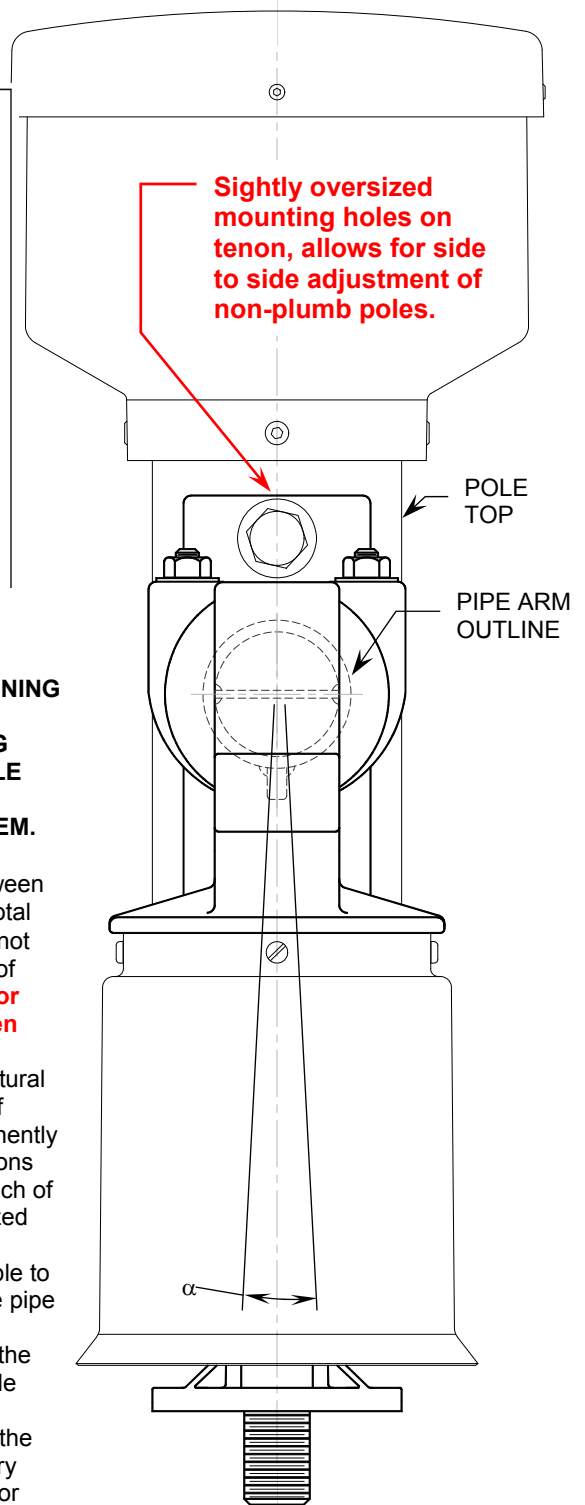
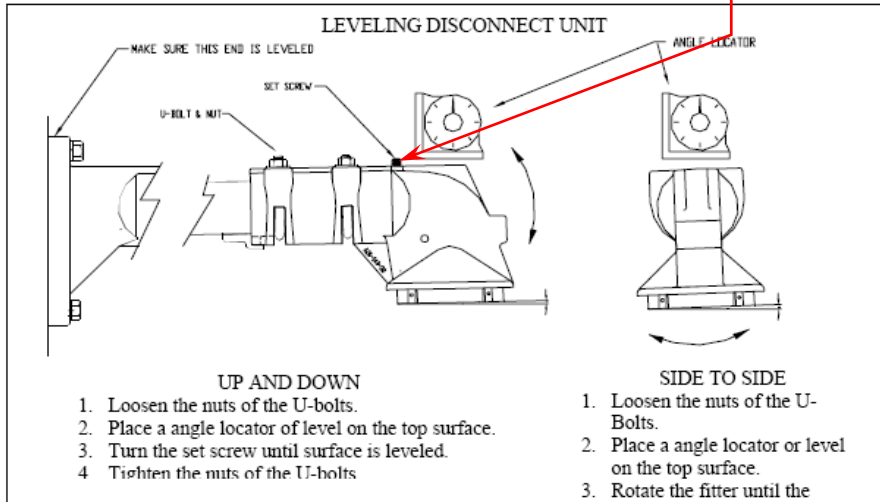

DETAILS OF FEATURES

NOTE: WHEN THE INTERLOCKING POSITIONING KEYS OF THE ARM ASSEMBLY ARE MATED WITH THE CORRESPONDING NOTCHES IN THE FITTERS, THE POLE SHAFT MUST BE PLUMB FOR THE PROPER OPERATION OF THE SYSTEM.

ANGLE α : The angle α shown in the END VIEW is based on mechanical tolerances between mating parts and should not exceed a total of $1/2^\circ$. This deviation from plumb will not affect the operation of the components of the arm assembly. **The angle allows for side to side adjustments needed when pole is not plumb.**

PIPE ARM: (See Fig. 1) Constructed of 2 inch structural steel pipe having an outside diameter of 2-3/8 inch. Positioning keys are permanently welded to the pipe arm at precise positions that align with notches in the ends of each of the fitters. Arm finish is hot dip galvanized after all welding is completed. Optional finishes over the galvanizing are available to match the color of the pole. Ends of the pipe arm bottom out against the inside of the fitters a small fraction of an inch before the keys bottom out in the notches to provide a secure fit.

The pipe arm is installed complete with the rest of the arm components at the factory and is pre-wired to eliminate any need for adjustment in the field.

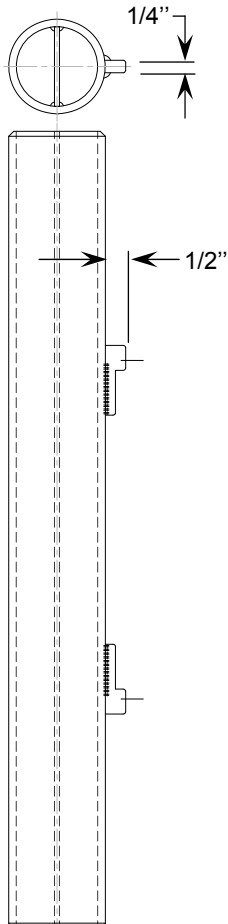
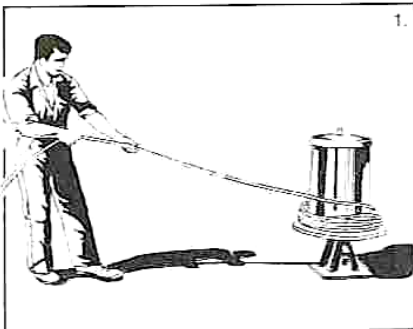
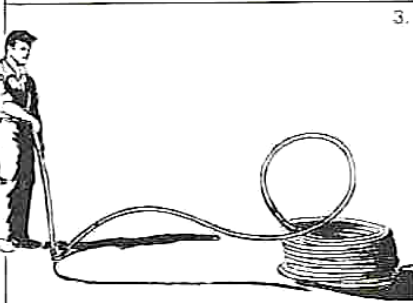

Fig. 1

END VIEW



1. Uncoiling – RIGHT METHOD
Place the coil on a swift or turntable, cut the tie-bands and pull the outer end of the rope away in a straight line, allowing the swift or turntable to rotate. (See Fig. 1).



2. Uncoiling -- RIGHT METHOD
Cut and remove the tie-bands and roll the coil along the ground leaving the rope lying straight on the ground.

3. Uncoiling – WRONG METHOD

4. Uncoiling – WRONG METHOD
Do not uncoil as shown in figs. 3 or 4 by placing the coil on the ground and pulling either the outside or inside ends of the rope away. The illustrations show the results. Kinks will be formed and the rope may be ruined. (See figs. 9, 10, and 11).

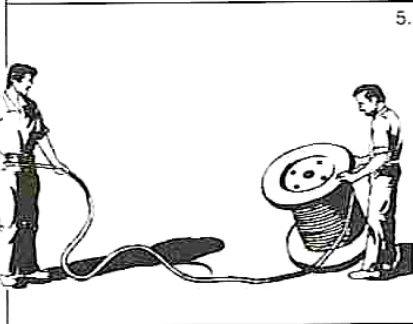

5. Unreeling – WRONG METHOD
Do not tilt the reel and “lap-off” the rope from the top side as shown in fig. 8. Kinks will be formed.

6. Unreeling – RIGHT METHOD
Put a shaft through the reel and jack up both ends to allow it to rotate freely. Pull the free end of the rope away in a straight line as shown in fig. 6.



7. Place the reel on its side on a vertical spindle and pull the free end of the rope in a straight line as the wheel rotates.

KINKS
A kink is caused by the rope taking a spiral set due to unnatural twist in the rope and is probably most frequently caused by faulty coiling and unreeling.

8. This shows the first stage of a kink. At this point, it can still be corrected and damage to the rope prevented by throwing out the loop.

9. This shows the result after the kink has been pulled through. The rope is now permanently damaged.

10. This shows the final result after the rope has been straightened. The wires and strands are permanently misplaced and the relative balance between individual wires and strands has been disturbed. No matter how slight the damage may appear from a superficial examination, the rope has been distorted and can never give the maximum life.

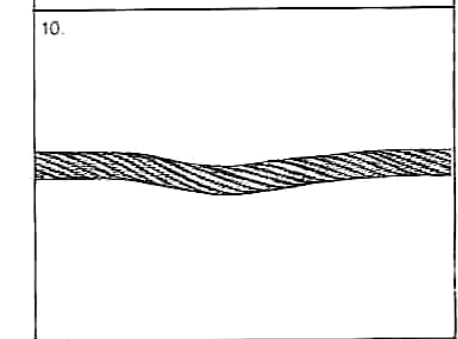
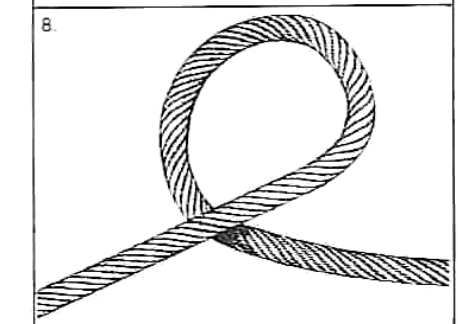
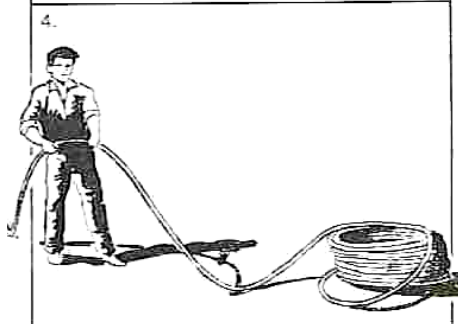
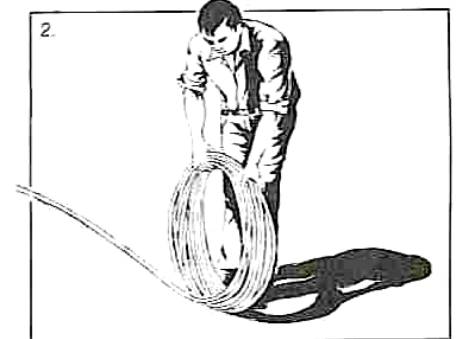

DRILL MOTOR TO WINCH DRIVE ADAPTOR WITH CLUTCH



ASSEMBLY AND USE INSTRUCTIONS

CATALOG NO. ACC-100-DRAD

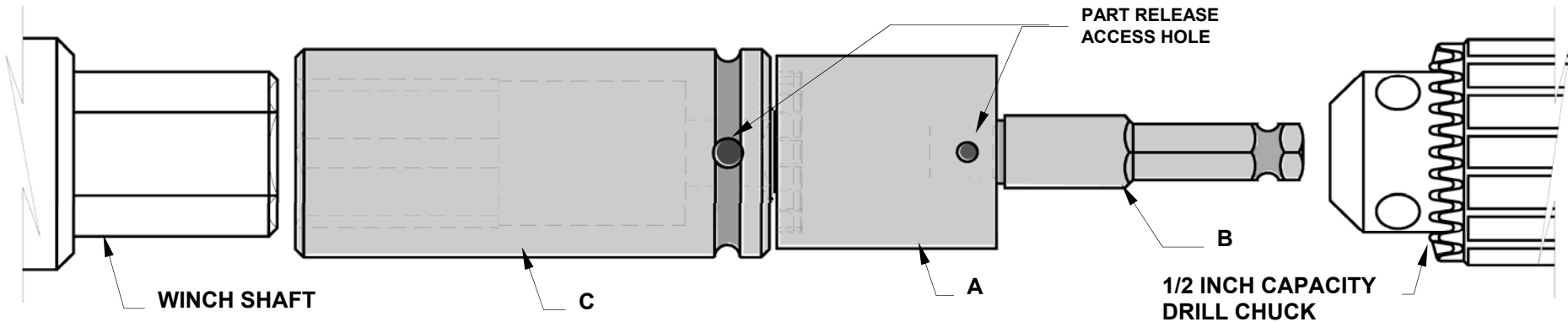

WARNING: TO REDUCE THE RISK OF PERSONAL INJURY AND TO AVOID SYSTEM DAMAGE, DO NOT OPERATE THE DRIVE ADAPTOR AT MORE THAN 350 RPM. **WEAR SAFETY GLASSES AT ALL TIMES DURING THE OPERATION OF THIS DEVICE.**

NOTES:

- ◆ DRIVE ADAPTOR MUST BE USED WITH A DRILL MOTOR HAVING AT LEAST A 1/2 INCH CAPACITY CHUCK, VARIABLE SPEED, REVERSIBLE, AND SHOULD BE RATED FOR 350 RPM (MAX. OPERATING SPEED) OR LESS.
- ◆ THE PURPOSE OF THIS DRIVE ADAPTOR IS TO PROVIDE A SAFE AND EFFICIENT MEANS OF RAISING AND LOWERING A POLE MOUNTED LUMINAIRE WITH THE ASSISTANCE OF A HAND HELD DRILL MOTOR. AN AUTOMATICALLY RESETTABLE TORQUE LIMITER (OVERLOAD CLUTCH) IS USED TO PROTECT THE OPERATOR AND THE SYSTEM FROM POTENTIALLY DAMAGING AMOUNTS OF TORQUE.
- ◆ THE HANDLE ASSEMBLY FOR THE HAND OPERATION OF THE WINCH SHOULD BE KEPT NEARBY AS IT IS NEEDED FOR THE LOCKING AND UNLOCKING OF THE ELECTRICAL CONTACT UNIT. FOLLOW THE PROCEDURE SPECIFIED WITHIN THESE INSTRUCTIONS.

CAUTION:

THE TORQUE LIMITER OF THIS DRIVE ADAPTOR IS INTENDED FOR THE EXPRESS LIFTING AND LOWERING OF A POLE MOUNTED LUMINAIRE. DO NOT USE THIS DRIVE ADAPTOR FOR ANY OTHER LIFTING OR PULLING PURPOSES NOT SPECIFIED WITHIN THESE INSTRUCTIONS.

THE PARTS OF THIS DRIVE ADAPTOR ARE PRE-ASSEMBLED AT THE FACTORY AND HAS A PRESET TORQUE OF APPROXIMATELY 240 lb.in. SHOULD IT BE NECESSARY TO DISASSEMBLE THE PARTS, USE A SMALL DIAMETER BLUNT TIPPED ROD OR PIN IN THE PART RELEASE ACCESS HOLE OF THE PART TO BE REMOVED, AND PUSH THE SPRING LOADED PIN IN UNTIL THE PARTS CAN BE PULLED APART.

IT SHOULD NOT BE NECESSARY TO ADJUST THE TORQUE SETTING ON THE TORQUE LIMITER (ITEM A), HOWEVER, SHOULD ADJUSTMENT BE REQUIRED, FOLLOW THE

INSTRUCTIONS ON THE SEPARATE SHEET SPECIFICALLY FOR THE TORQUE LIMITER MODEL 12 B. TORQUE RANGE: MIN. 240 lb. in.(27.1 Nm.) – MAX. 600 lb. in. (67.8 Nm.)

TO UNLOCK AND LOWER LUMINAIRE

1. Using the handle for the manual operation of the winch, operate the winch to raise the luminaire approximately 3/4 in. This will unlock the electrical disconnect unit. Operate the winch by hand to lower the luminaire enough to confirm that the luminaire is separated from the disconnect unit. Remove the manual use handle from the winch.
2. Insert the drill motor adaptor shaft (ITEM C) of the drive adaptor assembly into the chuck of the drill and tighten the chuck. Slip the 1-1/8 in. hex drive socket (ITEM D) of the drive adaptor over hex shaft of the winch until shaft is fully inserted into the socket. Keeping the drill and the drive adaptor in line with the winch shaft, operate the drill to lower the luminaire to the desired height for servicing. Be sure to keep drive socket over the winch shaft at all times during drill operation.

CAUTION:

SHOULD THE DRIVE SOCKET SLIP OFF OF THE WINCH SHAFT DURING LOWERING OR RAISING OPERATIONS, DO NOT ATTEMPT TO PUT DRIVE SOCKET BACK ON THE WINCH SHAFT UNTIL ALL PARTS HAVE STOPPED MOVING.

TO RAISE AND LOCK LUMINAIRE

3. After servicing the luminaire, slip the hex drive socket of the drive adaptor over the winch shaft completely and operate the drill at a moderate speed to raise the luminaire to a position that will place the moveable portion of the disconnect unit about one foot from engaging the fixed portion, and then stop the raising operation. To minimize pole shaking and vibrations it may be necessary to stop the operation periodically during the raising of the luminaire until movement subsides.

(continued on sheet 2 of 2)

DRILL MOTOR TO WINCH DRIVE ADAPTOR W/CLUTCH

ASSEMBLY AND USE INSTRUCTIONS

CATALOG NO. ACC-100-DRAD

TO RAISE AND LOCK LUMINAIRE (Continued)

WARNING:

DO NOT ATTEMPT TO RAISE THE LUMINAIRE INTO THE ELECTRICAL DISCONNECT UNIT WITHOUT STOPPING PRIOR TO ENGAGEMENT. AN EXCESSIVE AMOUNT OF TORQUE IS GENERATED WHEN THE LUMINAIRE AND ATTACHED GUIDE POST SPIN AROUND INTO POSITION WHEN MATING WITH THE FIXED PORTION OF THE DISCONNECT UNIT. TORQUE IS COMPOUNDED BY THE SIZE, WEIGHT, AND SHAPE OF THE LUMINAIRE. ENGAGEMENT OF THE MOVEABLE PORTION OF THE DISCONNECT UNIT (ATTACHED TO THE TOP OF THE LUMINAIRE) WITH THE FIXED PORTION OF THE DISCONNECT UNIT (ATTACHED TO END OF POLE MOUNTED ARM) SHOULD BE DONE SLOWLY TO CONTROL POTENTIALLY DAMAGING TORQUE.

4. Proceed to *SLOWLY* raise the luminaire by operating the drill motor in the raising direction at its slowest speed. The luminaire will noticeably turn as the disconnect unit is aligning for engagement. Continue to slowly raise the luminaire. When all parts are in proper position and at the very top, the raising motion will stop and an audible clicking will be coming from the torque limiter as the limiter slips. Additionally, noticeable jerking motion can be felt by the operator. Immediately stop the drill motor when the sound and jerking motion are sensed. Failure to stop the drill motor immediately will place unnecessary wear on the torque limiter and lead to reduced accuracy. At this stage, the luminaire and disconnect unit are all the way to the top and there is still tension on the cable.

NOTICE:

ATTEMPTING TO REVERSE THE DRILL MOTOR AND DRIVE ADAPTOR TO LOWER THE LUMINAIRE INTO THE 'LOCKED' POSITION WILL NOT, IN MOST CASES, SATISFACTORILY LOCK THE DISCONNECT UNIT AND REMOVE TENSION FROM THE CABLE. TORQUE REQUIRED FOR THIS OPERATION WILL BE GREATER THAN WHAT THE TORQUE LIMITER IS INTENDED FOR. ONLY HAND OPERATION OF THE WINCH IS RECOMMENDED.

5. Remove the drill motor and the drive adaptor from the winch shaft. Install the manually operated winch handle onto the winch shaft and secure. Operate the winch to lower the luminaire approximately 3/4 inch. Continue to operate the winch in the lowering direction until there is noticeable slack in the control cable, indicating that the luminaire and disconnect unit are in the locked position.

6. For additional information on the lowering system and the winch, refer to specific instructions for those items.

CAUTION:

ALWAYS BE SURE THAT THE SPRING ACTIVATED RETAINING PINS OF THE DRIVE COMPONENTS ARE ENGAGED WITH MATING PARTS PRIOR TO OPERATION OF THE DRIVE ADAPTOR.

MAINTENANCE AND CARE OF DRIVE ADAPTOR

- PERIODICALLY EXAMINE ALL MECHANICAL COMPONENTS FOR EXCESSIVE WEAR.
- REPLACE ANY PARTS THAT EXHIBIT EXCESSIVE WEAR OR VISIBLE DAMAGE SUCH AS CRACKS OR BENT SHAFTS.
- PROTECT PARTS FROM DIRECT CONTACT WITH WATER OR ANY OTHER CORROSIVE LIQUIDS.
- TORQUE LIMITER CONTAINS LUBRICATED PARTS. EXCESSIVELY HOT OR COLD TEMPERATURES MAY AFFECT THE ACCURACY OF THE TORQUE SETTING.
- CHECK ALL RETAINING PINS OF THE DRIVE COMPONENTS FOR PROPER OPERATION.

PARTS LIST

| Description | Qty. | Part Number |
|--------------------------------------|-------|-------------|
| A. ADJUSTABLE TORQUE LIMITER | 1 EA. | 12 B |
| B. 1/2" TO DRILL MOTOR ADAPTOR | 1 EA. | M-404 |
| C. 1-1/8" HEX DRIVE SOCKET | 1 EA. | 670-102-00 |
| RETAINING RING PLIERS (NOT SHOWN) | 1 EA. | Z-4 |

For replacement parts, contact:

Camera Lowering Systems at 708-681-4330

www.lowering-device.com



Camera Junction Box (CAMJB-10)



Camera to Camera Junction Box Flange (FLA-110)

STEP 1: Back out the two set screws on the 1.5" conduit thread, on the bottom of the Camera Junction Box.



STEP 2: Thread the flange onto the bottom of the CAMJB-10. Both male and female threads are National Pipe Straight (NPS).

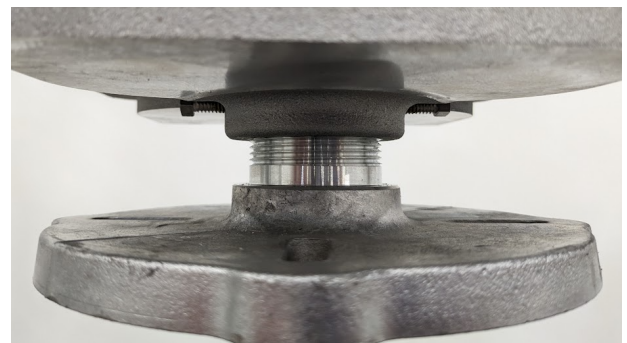

STEP 3: Thread until it stops. You should be able to thread 1" of threading.



Set screw backed out so as to not interfere with the threading of the flange.

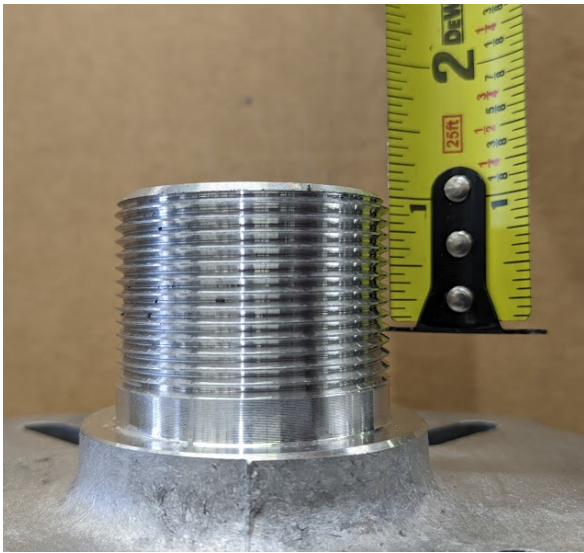

1" of threading was accomplished onto the CAMJB-10.

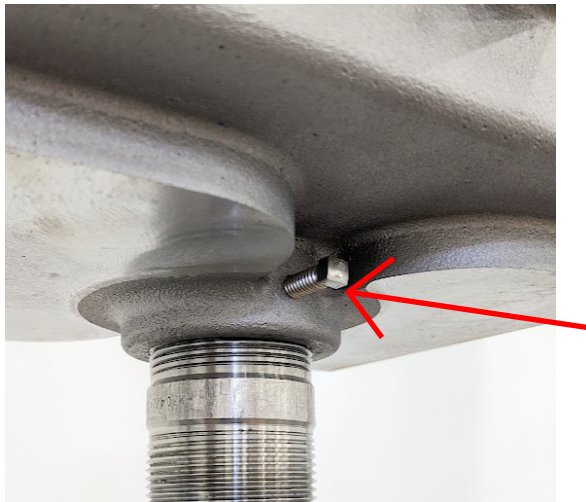

STEP 4: After the flange is threaded on, apply Loctite 271 Threadlocker (or equal) on to the setscrews. Tighten the setscrews evenly on both sides. The use of loctite is to keep the setscrews from vibrating loose.

PREVENTATIVE MAINTENANCE

Upon installation of the system, periodic preventive maintenance should be done to the system. The following is a list of preventative maintenance operations and schedule:

LOWERING TOOL

1. The tool should be kept in a clean and dry area.
2. During every usage of the Lowering Tool (LT-CC, LT-4), the raising and lowering cable should be checked for kinks, cut strands, and any irregularities, each time the tool is used. Do not run cable thru bare hands, as
3. The gears on the winch should be checked for gearing grease. If the gear box looks dry, gear grease should be applied on the gears only, with a small paint brush. The grease should be applied liberally covering all gears. Recommended grease should be **UNIWR1 2 product #C163520 Manufactured by: Fuchs Lubricants**. (PH: 800-800-OILS) This grease can be obtained through Camera Lowering Systems.
4. A drop of **10W-30 oil** should be applied in opening of casement (see sign on winch). Only apply one drop annually. After applying, crank the winch at least 3 revolutions to distribute the oil.
5. Check the cable for any kinks, bends, or stray cut wires. This will tell you if cable is rubbing on an obstruction. If cable is damaged, it will weaken the cable, possibly causing the cable to break. Damaged cables should be replaced. See attached "cable handling" page. Handle wire rope with gloves to avoid possible hand cuts caused by stray wires.

DISCONNECT UNIT

1. Each time the disconnect unit is lowered, check the condition of the system. If there are any signs of irregularities, such as scrapes, contact the factory.
2. Keep the guide pin cleaned and well lubricated with: 'Super Lube multipurpose grease with **Syncolon, manufactured by SYNCO CHEMICAL CORP**' or equivalent.
3. The locking cams should be checked each time the camera is lowered. Ensure shoulder screw is tightened. Add lubrication if needed on locking cam "rest button".
4. Lubrication should be "Super Lube" Multi-purpose grease with Syncolon[®] or equivalent heavy duty synthetic grease with temperature rating of -45°F to +450°F.
5. Check all screws, nuts and fastenings are tight.
6. Check composite cable for any irregularities.
7. The Camera Junction Box should be bolted to the disconnect unit using the four (4) ½-20 Hex screws with lockwashers provided by CLS. Torque Ratings: Torque rating on all ¼" bolts should be 20-25 LBXFT.
8. **CAMJB-10 set screws, LOCTITE RED is needed to secure the screws from vibration.**

GENERAL NOTES AND COMMENTS

Our raising and lowering system, using the **Individual Disconnect Unit (IDU)**, incorporates the locked suspension, which ensures the full weight of the camera is carried by the IDU, relieving the lowering tool, pulleys, and wire rope from tension. These in fact, only come under tension during the actual raising and lowering operations. It should be borne in mind, however, that even when the IDU is in the locked position, the lowering cable is attached to the lowering tool or the eyebolt, giving the unit a secondary suspension.

When the electrical connection is broken during unlocking and lowering, no live electrical wires are lowered with the camera.

CAUTION:

1. The camera should not be lowered during heavy winds.
2. **DO NOT STAND UNDER CAMERA DURING THE RAISING AND LOWERING OPERATIONS.**

LOWERING THE CAMERA

1. Read all instructions. If you do not understand any part of it, call your Sales Rep. or the factory, at 1 (800) 229-4330.
2. Bring the Portable Lowering Tool and drill to the pole.
3. With poles that have 2 service handholes, remove handhole covers from both handholes. If the pole has only one large handhole, remove the cover and set it aside. Do not misplace handhole cover screws.
4. Insert the Lowering Tool into the bottom handhole for a pole with 2 handholes (or the bottom of the handhole opening for a pole with one large handhole. Make sure that the handhole bracket clip "L" shaped piece catches underneath the inside of the handhole frame. (see the sketch).

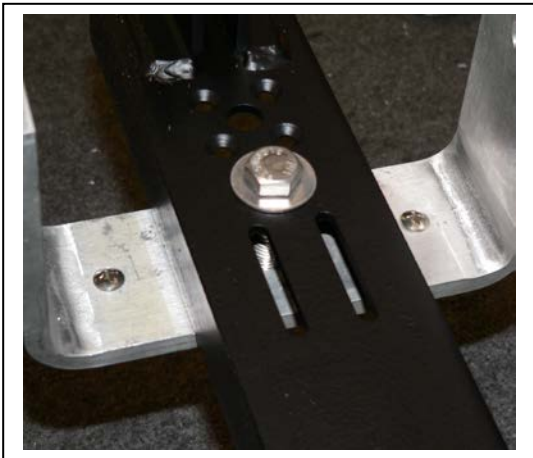

5. The bottom of the handhole has a 1/2"-13 tapped hole. Bolt the Lowering tool to the bottom of the handhole using the 1/2" bolt provided. This will stabilize the Lowering Tool to the pole.
6. Open the communications cabinet and check for electrical continuity of the camera.
7. Manually un-reel about 18 to 24" of cable from the winch drum.
8. Reach into upper handhole (for a pole with 2 handholes) and grab the cable that is connected to the camera being lowered. The cable should be attached to an eyebolt inside the pole.
9. Connect the lowering tool cable quick-link to the camera cable loop.

10. Close the quick-link to keep the lowering tool cable from slipping out.

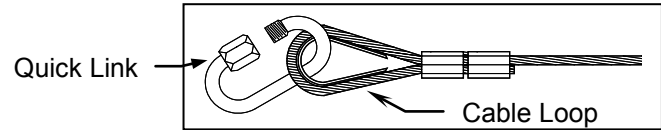

11. Disengage the camera-cable quick-link from the eye bolt in the pole.
12. Manually crank the lowering tool, winding the loose cable on the drum. When the loose cable has been wound up on the drum, continue cranking (or raising) until extra resistance is felt. During the unlocking process, the camera will raise 3/4" and then unlocks from the arm.

WARNING: DO NOT CONTINUE TRYING TO RAISE THE CAMERA WHEN ADDITIONAL RESISTANCE IS FELT because the cable will become tighter and tighter. As this occurs, damage to the cable or the Lowering Tool is possible, resulting in the camera disconnecting and falling to the ground.

13. After the camera is raised, reverse the cranking direction and manually lower the camera. If there is slack on the cable during the lowering process, repeat 12 above.
14. If a MANUAL lowering operation is used, continue cranking camera down until camera is about 4ft from the ground or until the operator sees slack on the drum cable. Slack on the drum cable means that the cable quick-link has reached the arm assembly mounted to the pole. The quick-link will not pass through the pulley assembly. The manual lowering operation is complete at this time.
15. If the DRILL ASSEMBLY is used, manually crank the camera and lower it 4ft from the top of the pole. Then the drill assembly can be used.
16. Make sure the drill direction is positioned for lowering the camera.
17. Remove the winch handle.

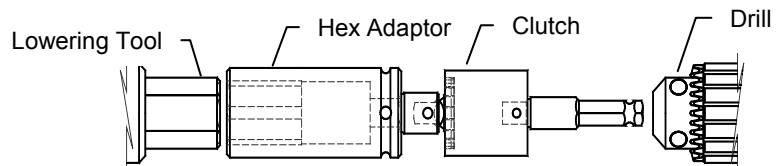

18. Attach the drill with clutch and adaptor, to the hex head on the winch (see drawing above). Although the Torque Limit is set at the factory, the torque limit may have to be field set.

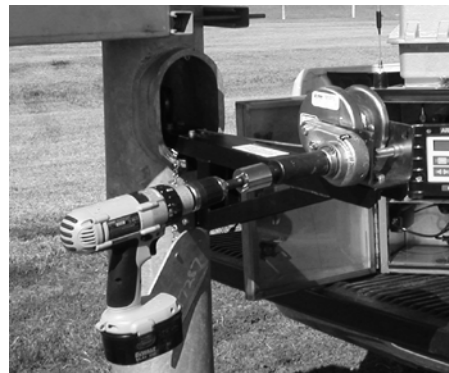

19. Lower the camera down (do not exceed 300 RPM with the drill) until the camera is about 4ft from the ground or until the operator sees slack on the cable. The lowering operation is complete at this time. **NOTE: USE THE DRILL PROVIDED BY CAMERA LOWERING SYSTEMS ONLY.** Higher revolutions will limit the life of the brake in

the winch. The brake keeps the camera from free falling during raising and lowering operations.

Torque Limiter

- Attach any calibrated torque indicator to output stub (1) and determine present torque setting while holding the body (5), or vice-versa.
- Remove snap ring (2) and locking plate (3).
- Adjust nut (4) with open-end wrench — clockwise to increase torque, counter-clockwise to decrease torque.
- Obtain new torque reading with the calibrated torque indicator. Repeat preceding step if more adjustment is necessary to reach desired limit.
- Replace locking plate into notches and install snap ring. If locking plate does not "seat," move the adjusting nut slightly until it drops in place. The direction is best determined by whether a minimum torque application or a maximum one is desired.

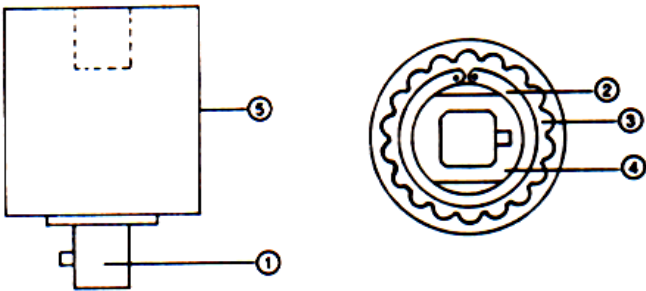

RAISING THE CAMERA

20. While in the lowered position, check the Disconnect Unit for any irregularities. If there are any signs of irregularities, contact the factory 1 (800) 229-4330. See the Preventative Maintenance section at the end of this document for other items to check.
21. Before raising the camera, a "jumper cable" can be used for connecting the Disconnect Unit to the cabinet, in order to test the camera.
22. After completing the maintenance of the camera, raise the camera to within 4ft of the top using the drill or the crank handle. **Do not exceed 300 RPM with the drill.**
23. If using the drill, remove the drill assembly and put the manual crank handle on to raise the final 4ft.
24. Crank at a medium to slow pace until the camera reaches the top. The camera may rotate up to 180° clockwise or counter clockwise.
25. When the camera reaches the top and the operator feels like the camera cannot be cranked up any further, **STOP** cranking upwards and slowly reverse the cranking direction. **DO NOT OVERCRANK!**
26. The reversed cranking direction will lower the camera into the locked or resting position. The operator should see slack on the cable and on the lowering tool after about ½ of a crank revolution. Check the communications cabinet. The camera should be energized.

27. With the slack on the cable and the camera cable still attached to the Lowering Tool cable, attach the camera cable quick link, to the eyebolt in the pole.
28. After the cable is attached to the eyebolt and the connecting quick-link is closed, disengage the Lowering Tool cable from the camera's cable. **Two quick links should always be used during the unlocking and locking procedures.**
29. Loosen the outside handhole bracket on the lowering tool and push the Lowering Tool slightly into the pole.
30. Lift up and remove the Lowering Tool from the lower handhole.
31. Install the handhole covers back on the pole.
32. Close and secure the communications cabinet.

Preventive Maintenance

Upon installation of the lowering system, periodic preventive maintenance should be performed. The following is a list of preventive maintenance operations and schedule:

LOWERING TOOL

1. The tool should be kept in a clean and dry area.
2. During every use of the Lowering Tool, the raising and lowering cable should be checked for kinks, cut strands, and any irregularities. Do not run the cable using bare hands, as strayed strands could cause cuts and injuries to hands.
3. The gears on the winch should be checked for gearing grease. If the gear box looks dry, gear grease should be applied on the gears only, with a small paint brush. The grease should be applied liberally to cover all gears. Recommended grease should be UNIWRI 2 product #C163520 Manufactured by: Fuchs Lubricants. (Phone: 800-800-OILS) This grease may be obtained through *Camera Lowering Systems*.
4. A drop of 10W-30 oil should be applied in opening of casement (see label on the winch). Only apply one drop annually. After applying, crank the winch at least 3 revolutions to distribute the oil.
5. Check the cable for any kinks, bends, or strayed cut wires. This will tell you if the cable is rubbing on an obstruction. If the cable is damaged, it will be weakened and possibly break. Damaged cables should be replaced. Handle the wire rope with gloves to avoid possible hand cuts caused by strayed wires.

DISCONNECT UNIT

1. Each time the Disconnect Unit is lowered, check the condition of the system. If there are any signs of irregularities (such as bent parts, missing hardware, or frayed cable) contact the factory.
2. Keep the guide pin greased and cleaned. Brush on *Super Lube®* by *Synco Chemical* (can be purchased through *Camera Lowering Systems*).
3. The locking cams should be checked each time the camera is lowered. Ensure that the shoulder screw is tightened. Check all screws, nuts, and fastenings to ensure that they are tight.
4. Check the composite cable for any irregularities.

If the system does not operate properly, repeat steps 1-32 two more times, adjusting the torque on the torque limiter if necessary. The torque model is the 12A. It is set at the factory at the Min. setting of 240 lb./in. (27.1 Nm.). The max setting is 600 lb./in. (67.8 Nm.).